

INSTALLATION INSTRUCTIONS

8" x 5" WALL PACK LUMINAIRE

VJTUNV010LNxyyB05

1.0 INSTALLATION WARNINGS

1. "THIS PRODUCT MUST BE INSTALLED IN ACCORDANCE WITH THE APPLICABLE INSTALLATION CODE BY A PERSON FAMILIAR WITH THE CONSTRUCTION AND OPERATION OF THE PRODUCT AND HAZARDS INVOLVED."
2. "WARNING - Risk of fire or electric shock. LED Retrofit kit installation requires knowledge of luminaires electrical systems. If not qualified, do not attempt installation. Contact a qualified electrician."
3. "WARNING - Risk of fire or electric shock. Install this kit only in the luminaires that has the construction features and dimensions shown in the photographs and/or drawings and where the input rating of the retrofit kit does not exceed the input rating of the luminaire."
4. "WARNING - To prevent wiring damage or abrasion, do not expose wiring to edges of sheet metal or other sharp objects."
5. "WARNING –Risk of fire or electric shock. Luminaire wiring and electrical parts may be damaged when drilling for installation of LED retrofit kit. Check for enclosed wiring and components."
6. "CAUTION – RISK OF FIRE. CONSULT A QUALIFIED ELECTRICIAN TO ENSURE CORRECT BRANCH CIRCUIT CONDUCTOR."
7. "THE RETROFIT KIT IS ACCEPTED AS A COMPONENT OF A LUMINAIRE WHERE THE SUITABILITY OF THE COMBINATION SHALL BE DETERMINED BY THE AUTHORITIES HAVING JURISDICTION."
8. Do not make or alter any open holes in an enclosure of wiring or electrical components during kit installation.

1.0 AVERTISSEMENTS D'INSTALLATION

1. CE PRODUIT DOIT ÊTRE INSTALLÉ SELON LE CODE D'INSTALLATION PERTINENT, PAR UNE PERSONNE QUI CONNAÎT BIEN LE PRODUIT ET SON FONCTIONNEMENT AINSI QUE LES RISQUES INHÉRENTS.
2. AVERTISSEMENT - Risque d'incendie ou de choc électrique. L'installation de ce nécessaire de modernisation exige une personne familière avec la construction et le fonctionnement du système électrique du luminaire et des risques associés. Toute personne qui n'est pas qualifiée ne doit faire aucune tentative d'installation et doit contacter une personne qualifiée.
3. AVERTISSEMENT - Risque d'incendie ou de choc électrique. N'installer ce nécessaire que dans les luminaires dont les caractéristiques de construction et les dimensions sont conforme à celles illustrées dans les photos et/ou les dessins et dont la puissance d'entrée nominale du nécessaire de modernisation ne dépasse pas celle du luminaire.
4. AVERTISSEMENT - Afin de prévenir l'endommagement ou l'abrasion des câbles, éviter tout contact entre ces derniers et le bord d'un objet tranchant tel qu'une tôle.
5. "AVERTISSEMENT -Risk d'incendie ou de choc électrique. Le câblage du luminaire et les pièces électriques peuvent être endommagés lors du forage pour l'installation d'un kit de reconditionnement LED. Vérifiez le câblage et les composants inclus. "
6. ATTENTION – RISQUE D'INCENDIE, CONSULTER UN ÉLECTRICIEN QUALIFIÉ POUR VOUS ASSURER QUE LES CONDUCTEURS DE LA DÉRIVATION SONT ADÉQUATS.
7. LE NÉCESSAIRE DE MODERNISATION EST ACCEPTÉ À TITRE DE COMPOSANT D'UN LUMINAIRE LORSQUE LA PERTINENCE DE LA COMBINAISON DOIT ÊTRE DÉTERMINÉE PAR LES AUTORITÉS COMPÉTENTES.
8. Ne faites pas ou ne modifiez aucun trou ouvert dans une enceinte de câblage ou de composants électriques pendant l'installation du kit

2.0 ORIGINAL LUMINAIRE DIMENSIONS

Original Luminaire
(RLR: V58)



Minimum Luminaire
Dimensions

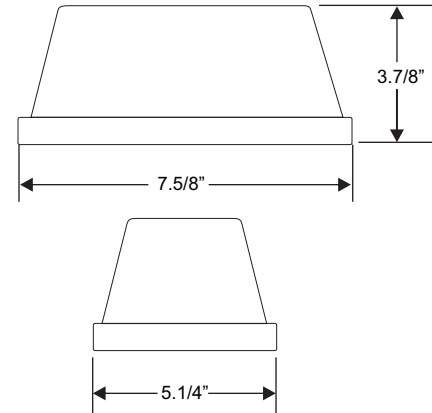

- Remove all the original luminaire parts, hardware, lamp, and ballast in order to begin the retrofit.
- Original luminaire diffuser and original ground wire will need to be kept for this retrofit.
- This Kit can be retrofitted into any luminaire with a similar length/height width greater than or equal to the Minimum Luminaire Dimensions described above or volume greater or equal to 109.8 cubic inches.

NOTE: Wire on dedicated lighting branch circuit. Do not wire on same branch circuit as motors, heating elements, inductive type loads or heavy machinery which may introduce spikes, noise and other abnormalities onto the Line. Doing so may result in damage to the unit or abnormal lighting conditions.

3.0 RETROFIT KIT COMPONENTS

Retrofit kit components will be provided as listed below:

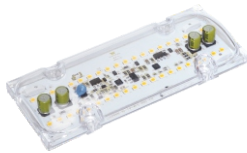

LED Engine



Mounting Hardware

This luminaire has been modified and can no longer operate the originally intended lamp.
 Ce luminaire a été modifié et ne peut plus utiliser la lampe prévue à l'origine.

Retrofit Label



Input Connector

4.0 RECOMMENDED TOOLS (Not Included)

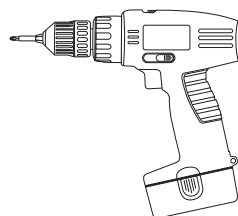

Power Drill W/ Phillips Bit

5.0 RETROFIT KIT DESCRIPTION

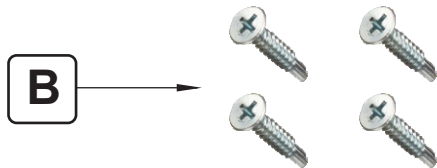
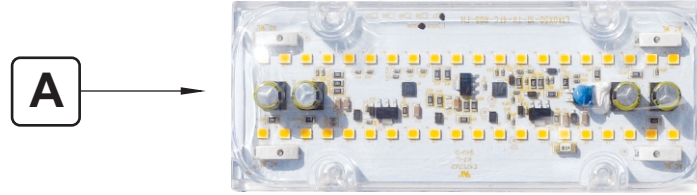

C → This luminaire has been modified and can no longer operate the originally intended lamp.
Ce luminaire a été modifié et ne peut plus utiliser la lampe prévue à l'origine.

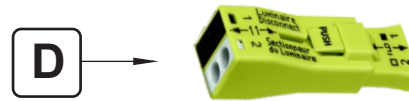

ITEM	DESCRIPTION	QTY
A.	LED AC Engine	1
B.	6-20 X 3/8" Self Drilling Screws	4
C.	Retrofit Label	1
D.	Input Connector (may vary from picture)	1

6.0 ORIGINAL LUMINAIRE DISASSEMBLY

1. Start by removing the Lens from the luminaire. See Picture #1.

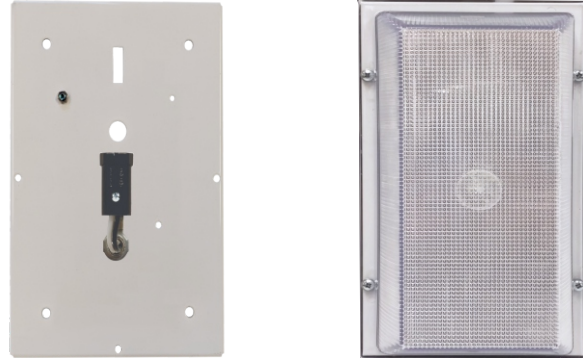

Picture #1

2. Remove the lamp and lamp socket from the luminaire. See Picture #2.
3. The original luminaire ground wire will need to be kept for this retrofit.

The luminaire back plate should look like Picture #2 in order to begin the retrofit.



Picture #2

7.0 RETROFIT KIT ASSEMBLY

1. Start by inserting wires into the input connectors on either side of the LED Engine (A). See Figure 1.

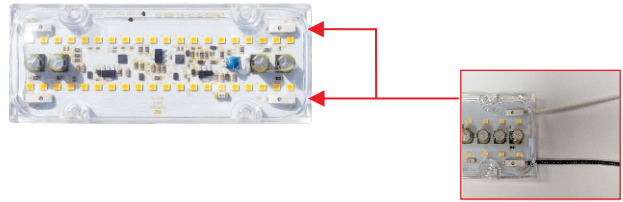

Figure 1

Insert input leads Into LED Engine

2. Route the input wires of LED Engine (A) into the wire hole of the luminaire back plate and place the LED Engine (A) onto the luminaire back plate as shown on Figure 2.

NOTE: LED Engine must make direct contact with the back plate when installed in order to provide sufficient heat sinking to properly manage thermals for safety and warranty purposes. The insulation film on the back of the engine should never be removed.

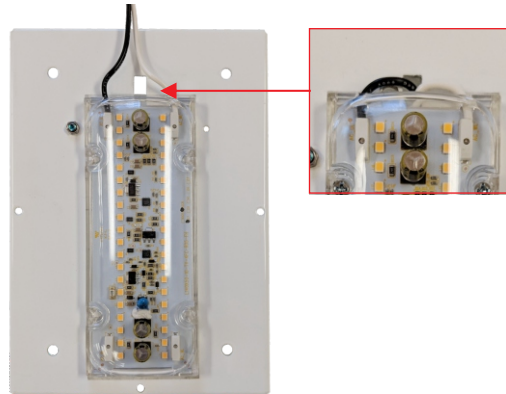

Figure 2

3. Secure the LED Engine to the luminaire mounting plate using the provided 6-20 x3/8" Self Drilling Screws (B). See Figure #3.

NOTE: All screws provided must be used to ensure good thermal contact to surface.

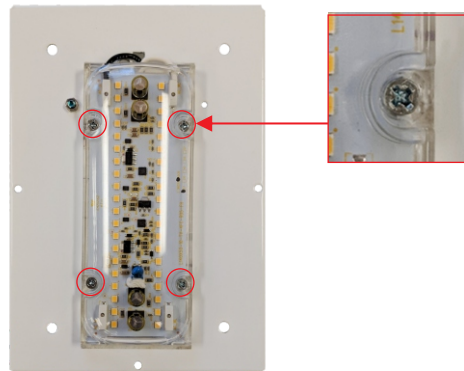

Figure 3

7.0 RETROFIT KIT ASSEMBLY

- Place the provided Retrofit Label (C) on the luminaire back plate in a readily visible location to anyone attempting to service the luminaire. See Figure 4.
- Completed retrofit should look like Figure 4.

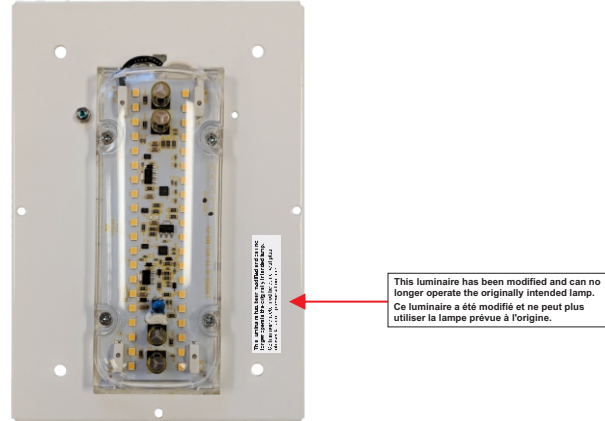

Figure 4

- The luminaire is now ready to be installed. Please see below for instructions on connecting line voltage to the luminaire.
- Re-attach and secure the lens once installation is completed, retrofit should look like Figure 5.



Figure 5

Connecting Power to the Retrofit Kit:

- Connect the green wire (Ground) from the luminaire to the Ground that is being fed by the power source. Connect these two wires by using a wire connector with a minimum 18AWG rating.
- Connect the white wire (Neutral) from the DirectAC Engine to the Neutral being fed by the power source. Connect these two wires by using a wire connector with a minimum 18AWG rating.
- Connect the Black wire (Line) from DirectAC Engine to the Line being fed by the power source. Connect these two wires by using a wire connector with a minimum 18AWG rating.

8.0 WARRANTY

- Please refer to Linear AC Engine kit spec sheet for warranty information