



SHS-DISP

Display and Communication Device

- Compatible with Programmable SunHorse Ballasts.
- Programmable Lamp and Ballast Hour Counter.
- Audible Alarm for use with lamp hour counter.
- BMS Signal Output (5VDC)
- NO/NC Relay
- Ballast / Lamp Servicing interface through USB-C port.
- Real Time Ballast/Lamp Data Logging.
- I²C Sensor capable.
- Multiple Ballast Communication.
- Analog Input for use with lamp hour logging on non-I²C ballasts with LED indicator ports.

General Specifications

Input Power Source	I ² C, 12VAC – 24VAC, 24VDC			
Power Type	I ² C	12VAC - 24VAC	24VDC	USB
Connection Type	RJ12 Port	Push Terminal	Barrel Jack	USB-C
Electrical Parameters	Vmin / Imin: 4.75VDC/10mA	Vmin / Imin: 12VAC/75mA	Vmin / Imin: 22.8VDC/16mA	Vmin / Imin: 4.75VDC/10mA
	Vmax / Imax: 5.25VAC/100mA	Vmax / Imax: 26.4VAC/166mA	Vmax / Imax: 25.2VDC/90mA	Vmax / Imax: 5.25VAC/100mA
Power Line Frequency	50/60HZ @ 12VAC-24VAC Input			
Operating Ambient Temperature	-20°C to 50°C (-4°F to 122°F)			
Ballast Communication Type	I ² C			
I ² C Communication Cable Type	RJ12 with 6 wires			
Display Cable Length	22" (558.8mm)			
Ballast Communication / Sensor Port	Yes			
	Connection Type: RJ12 Port Electrical Parameters: Vmin / Imin: 4.75VDC/10mA , Vmax/Imax: 5.25VAC/100mA			
Ballast Lamp Servicing Interface Port	USB-C			
Fulham Smart Set Compatible	Yes			
Multiple Ballast Communication Capable	Yes			
I ² C Sensor Add-on Capable	Yes			
Display I ² C Sensor Data	Yes			
Display Ballast Information	Yes			
Ballast Programming Capable	Yes			
5V Analog / Digital Input	Yes			
	Connection Type: Push Terminals Electrical Parameters: Vmin / Imin: 4.75VDC/0mA , Vmax / Imax: 5.25VAC/1mA			
NO / NC Relay	Yes			
	Connection Type: Push Terminals Electrical Parameters: Vmin / Imin: 0V/0A , Vmax/Imax AC: 305VAC/3A, Vmax/Imax DC: 30VDC/6A			
5V Signal Output (BMS) For Lamp Status	Yes			
	Connection Type: Push Terminals Electrical Parameters: Vmin / Imin: 4.75VDC/0mA , Vmax/Imax: 5.25VAC/1mA			
Audible Alarm	Yes			
Ballast / Lamp Data Logging	Yes			
Programmable Lamp Hour Counter	Yes			
Programmable Ballast Hour Counter	Yes			
Ballast Soft Start Compatible	Yes			
Dimensions	L: 4.93" (125mm) x W: 3.35" (85mm) x H: 1.09" (27.8mm)			
Warranty	5 Years from the date of manufacture.			



SHS-DISP

Compatible I²C Ballast

- SHS1P-UNV-C
- SHS4P-UNV-C
- SHS5P-UNV-C
- SHS11P-UNV-H
- SHS14P-UNV-H
- SHS15P-UNV-H

Images

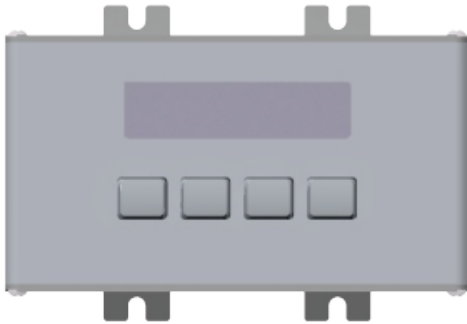
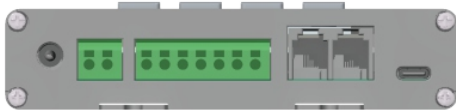

Mechanical Data

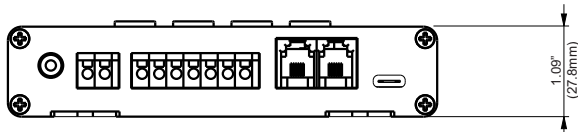

Back View

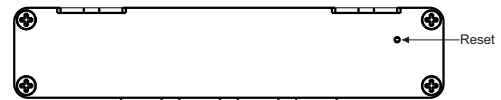

Front View

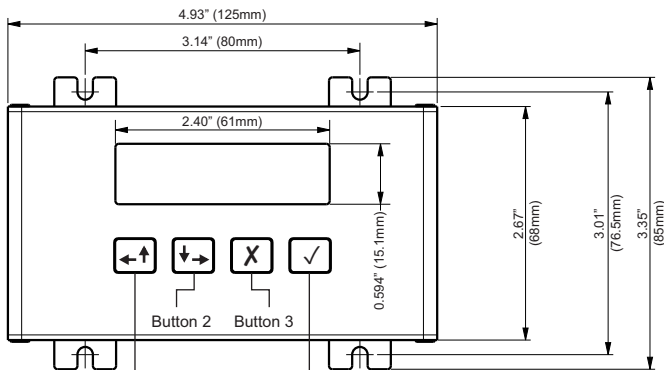

Top View

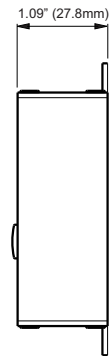

Side View



SHS-DISP

Wiring Diagram

Single Ballast

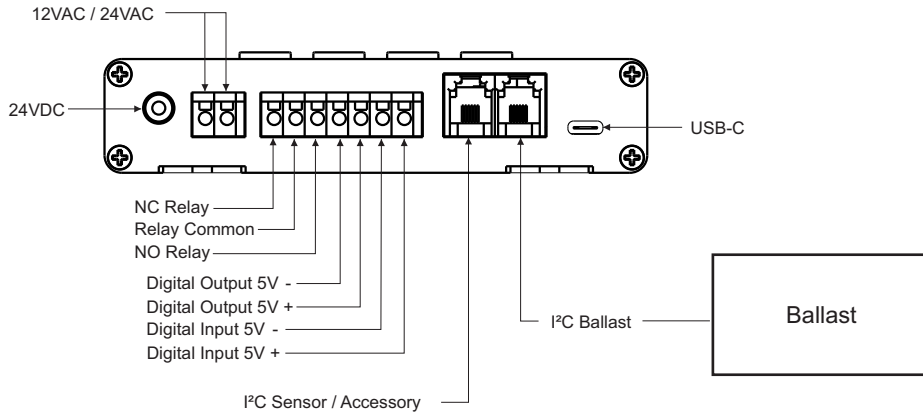

Multiple Ballast

